

K&S METAL ENCLOSURES
 24X32X10 PECO SECONDARY METERING
 CABINET
 CATALOG #: 2-10

- NOTES:
- NEMA 1, DOUBLE DOOR WALL MOUNTED
 - 14 GAUGE GALVANIZED

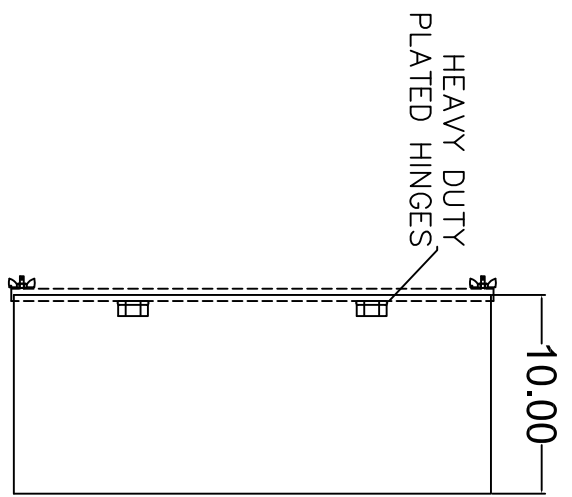

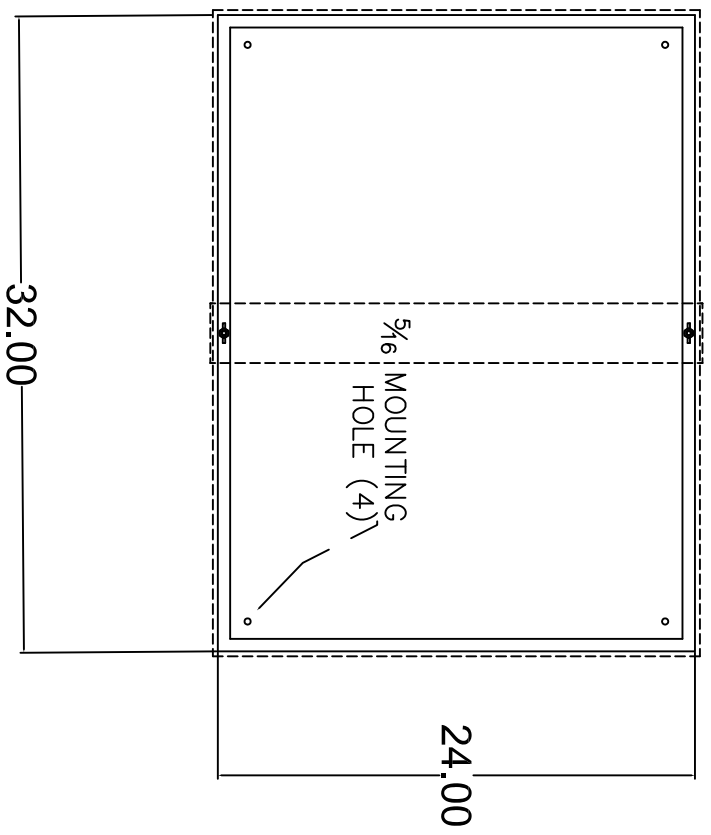
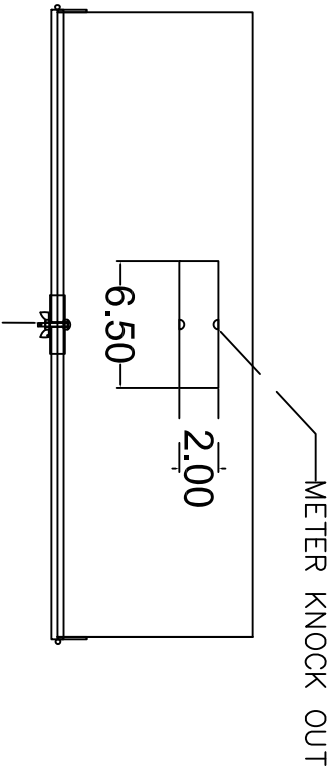

PROVISIONS FOR
UTILITY SEAL

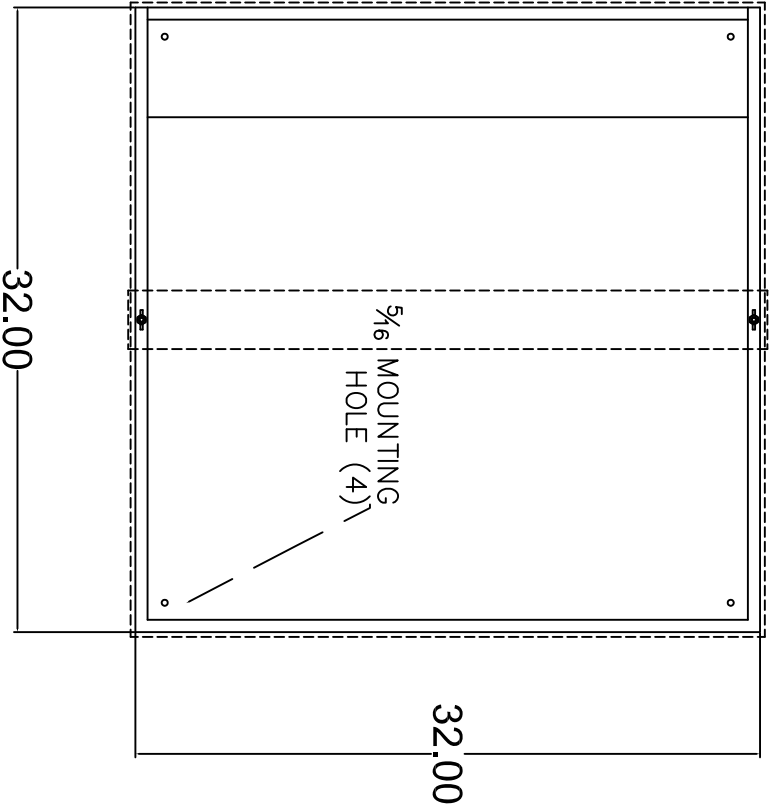

K&S METAL ENCLOSURES
32X32X10 PECCO SECONDARY METERING
CABINET
CATALOG #: 3-10

NOTES:

- NEMA 1, DOUBLE DOOR WALL MOUNTED
- 14 GAUGE GALVANIZED

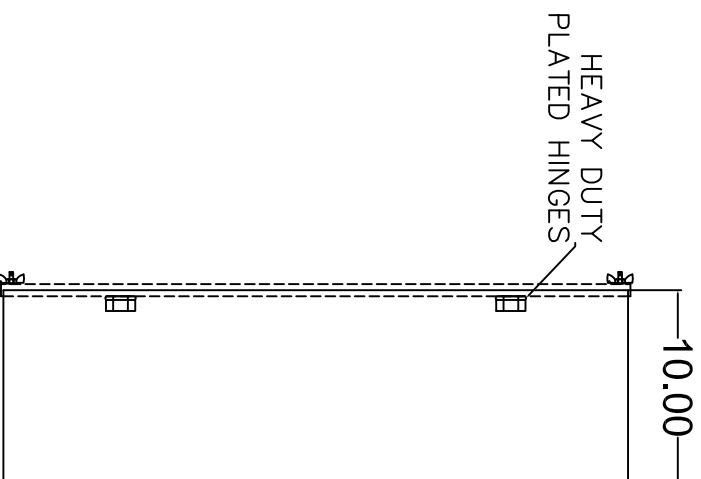

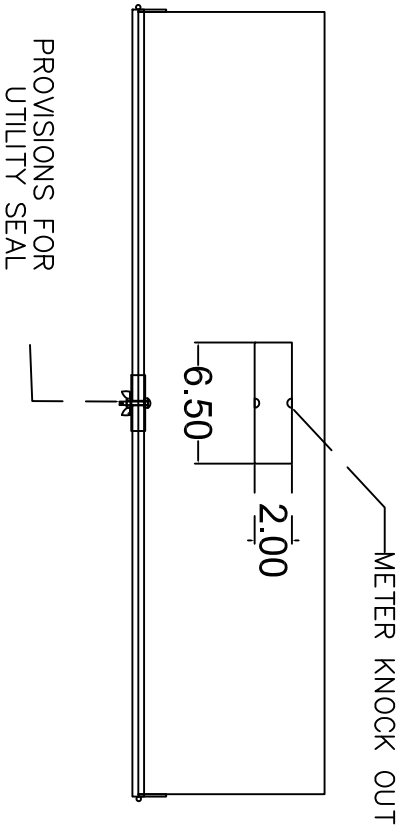

K&S METAL ENCLOSURES
 32X42X10 PECO SECONDARY METERING
 CABINET
 CATALOG #: 4-10

- NOTES:
- NEMA 1, DOUBLE DOOR WALL MOUNTED
 - 14 GAUGE GALVANIZED

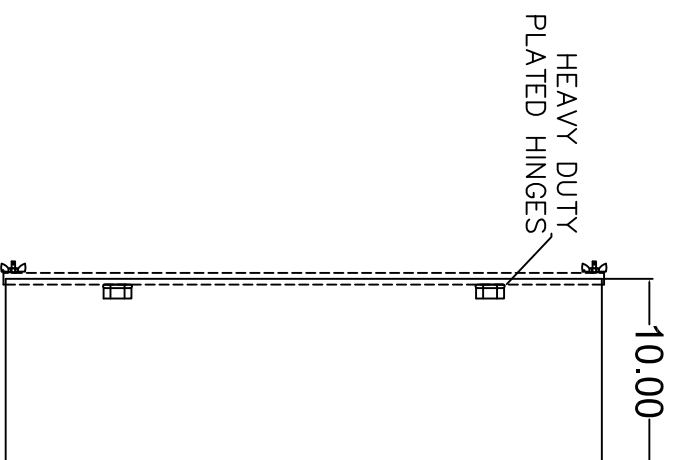
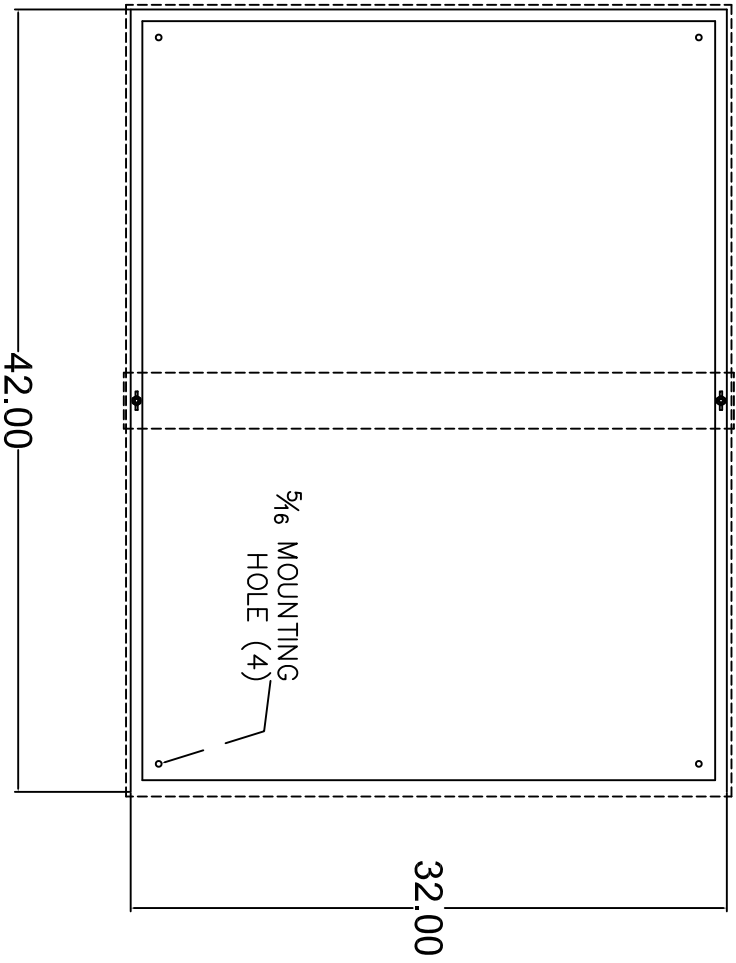

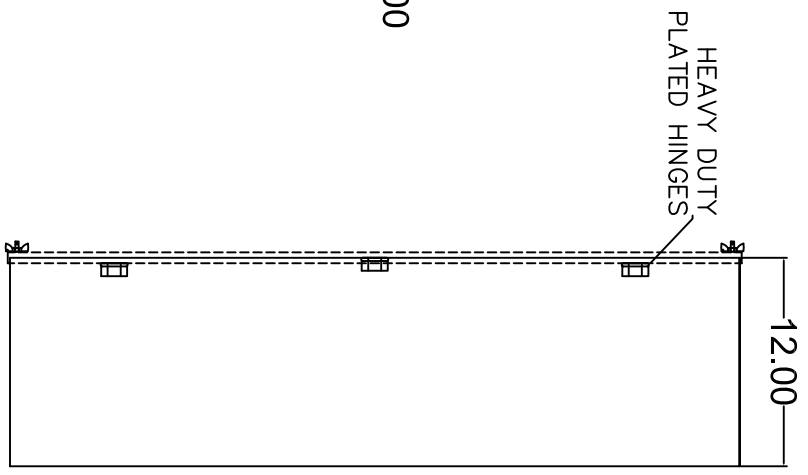
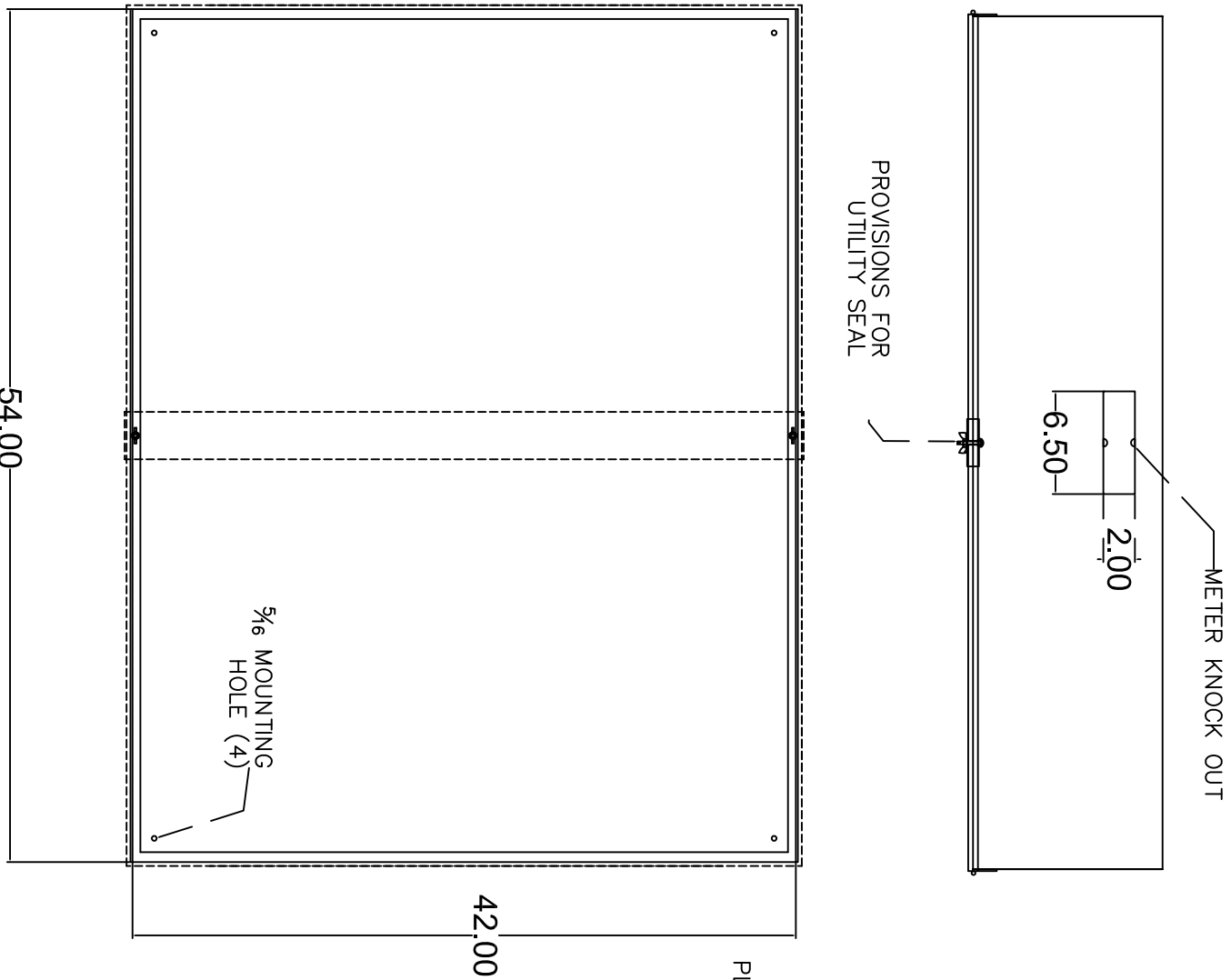

K&S METAL ENCLOSURES
 42X54X12 PECO SECONDARY METERING
 CABINET
 CATALOG #: 5-12

- NOTES:
- NEMA 1, DOUBLE DOOR WALL MOUNTED
 - 14 GAUGE GALVANIZED

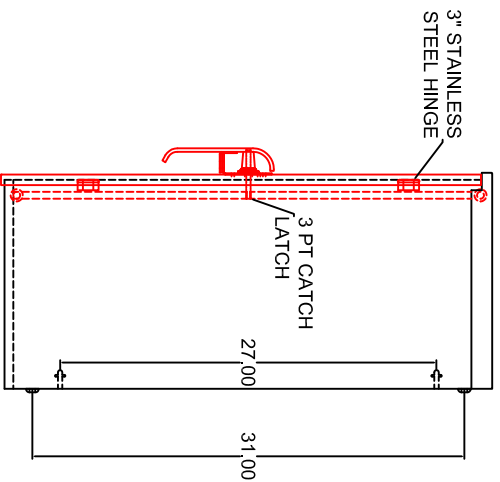
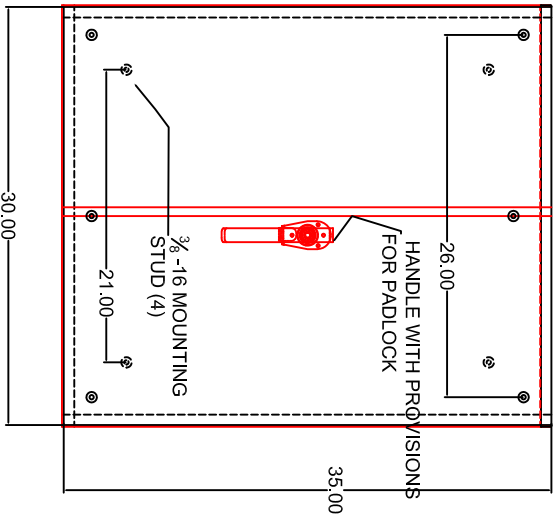
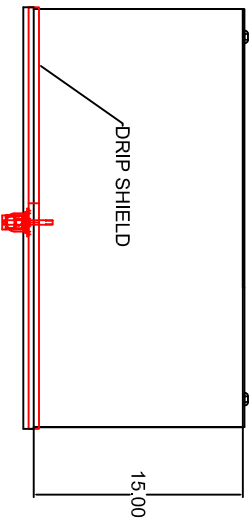

K&S METALS
 35 X 30 X 15 NEMA 3R CT
 CABINET
 PECCO #: M3530

- NOTES:
- NEMA 3R OUTDOOR CONSTRUCTION
 - MOUNTING HOLES TOP & BOTTOM
 - OVERLAPPING DOORS ARE FURNISHED WITH 3PT CATCH HANDLE & AND LIFT-OFF TYPE HINGES
 - 3/16 -16 STUDS FOR CURRENT TRANSFORMER MOUNTING
 - TOP MOUNTED DRIP SHIELD PROTECTS AGAINST FALLING RAIN, SLEET, AND EXTERNAL ICE FORMATION
 - 14 GAUGE GALVANIZED STEEL FINISH

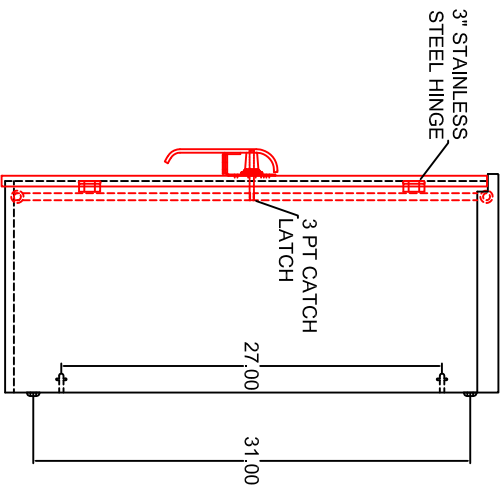
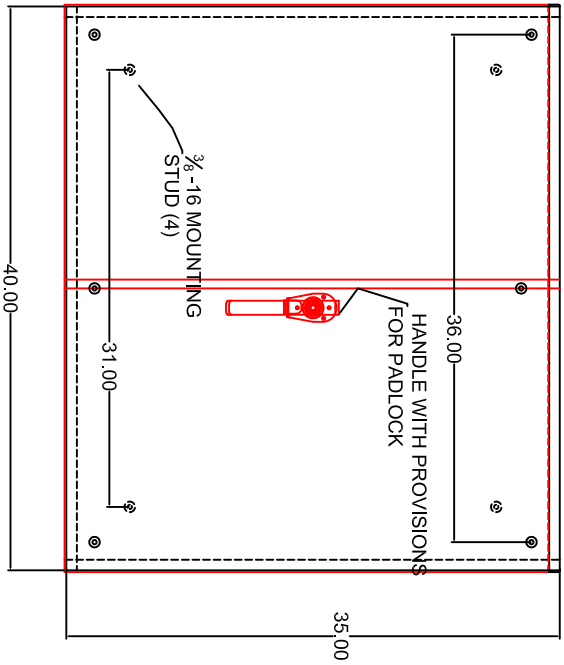
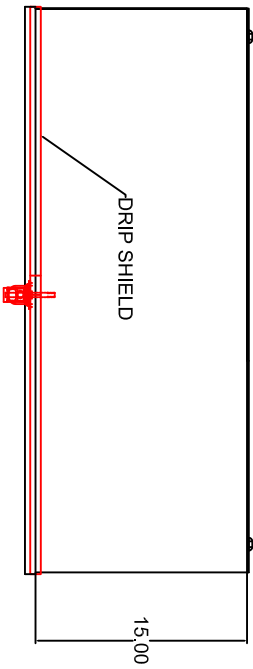

K&S METALS
 35 X 40 X 15 NEMA 3R CT
 CABINET
 PECO #: M3540

- NOTES:
- NEMA 3R OUTDOOR CONSTRUCTION
 - MOUNTING HOLES, TOP & BOTTOM
 - OVERLAPPING DOORS ARE FURNISHED WITH 3PT CATCH HANDLE & LIFT-OFF TYPE HINGES
 - 3/8\" -16 STUDS FOR CURRENT TRANSFORMER MOUNTING
 - TOP MOUNTED DRIP SHIELD PROTECTS AGAINST FALLING RAIN, SLEET, AND EXTERNAL ICE FORMATION
 - 14 GAUGE GALVANIZED STEEL FINISH

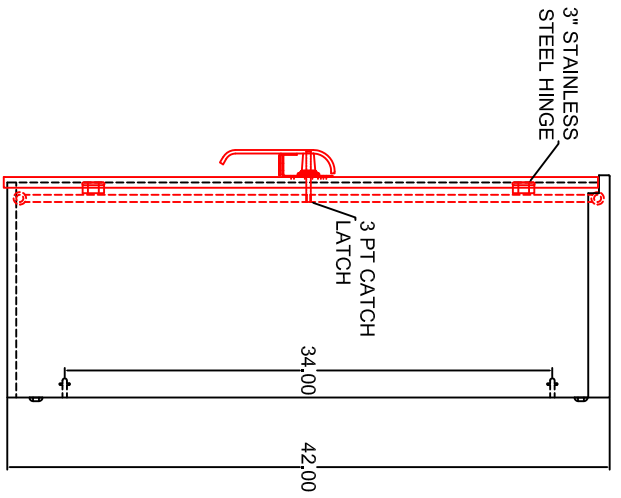
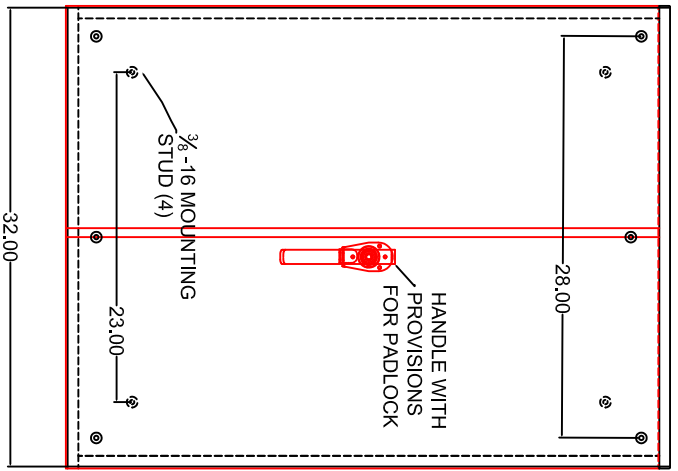
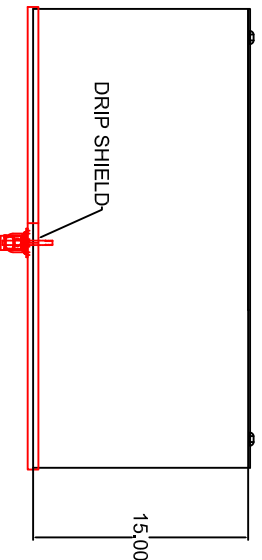

K&S METALS
 42 X 32 X 15 NEMA 3R CT
 CABINET
 PECO #: M4232

- NOTES:
- NEMA 3R OUTDOOR CONSTRUCTION
 - MOUNTING HOLES TOP & BOTTOM
 - OVERLAPPING DOORS ARE FURNISHED WITH 3PT CATCH HANDLE & LIFT-OFF TYPE HINGES
 - $\frac{3}{8}$ -16 STUDS FOR CURRENT TRANSFORMER MOUNTING
 - TOP MOUNTED DRIP SHIELD PROTECTS AGAINST FALLING RAIN, SLEET, AND EXTERNAL ICE FORMATION
 - 14 GAUGE GALVANIZED STEEL FINISH

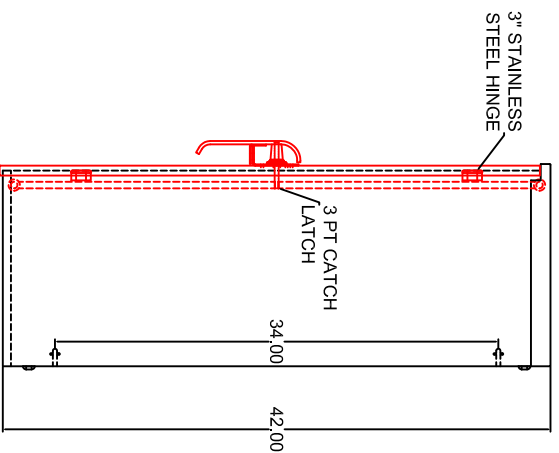
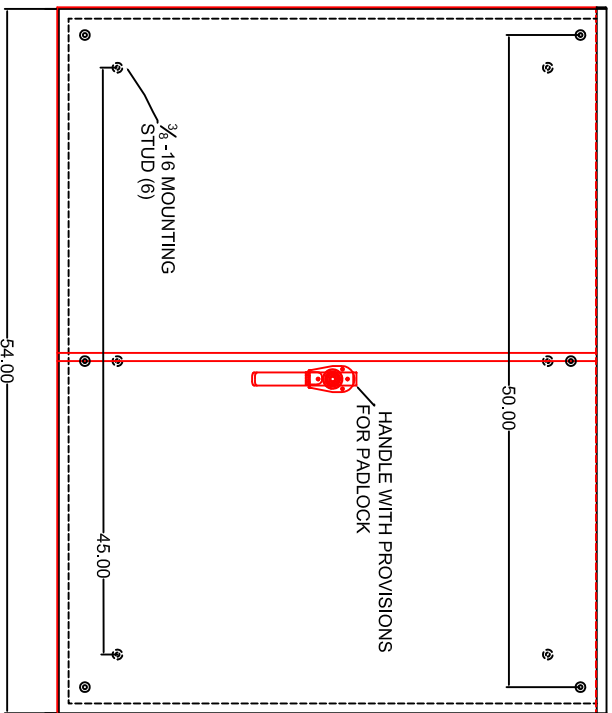
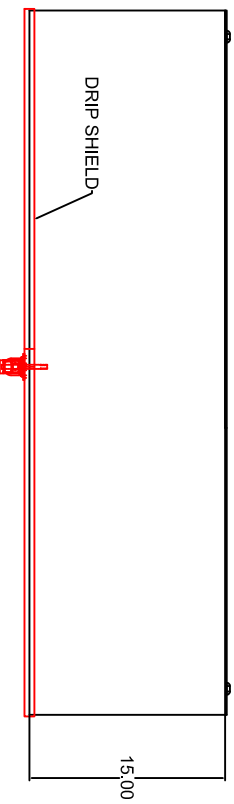

K&S METALS
 42 X 54 X 15 NEMA 3R CT
 CABINET
 PECO #: M4254

- NOTES:
- NEMA 3R OUTDOOR CONSTRUCTION
 - MOUNTING HOLES TOP & BOTTOM
 - OVERLAPPING DOORS ARE FURNISHED WITH 3PT CATCH HANDLE & LIFT-OFF TYPE HINGES
 - $\frac{3}{8}$ "-16 STUDS FOR CURRENT TRANSFORMER MOUNTING
 - TOP MOUNTED DRIP SHIELD PROTECTS AGAINST FALLING RAIN, SLEET, AND EXTERNAL ICE FORMATION
 - 14 GAUGE GALVANIZED STEEL FINISH

K&S METAL ENCLOSURES
 END BOXES FOR SERVICE CONDUCTORS
 (UNDERGROUND ENTRANCE BOXES)

REFERENCE: PECO ELECTRIC SERVICE REQUIREMENTS
 MANUAL
 SECONDARY SERVICES, REV 2; SECTION 6.3.1.1 END
 BOX SIZES

OPENING IN BACK OF BOX
 FOR ENTRANCE OF SERVICE
 DUCTS AND CONDUCTORS
 SEE SIZE

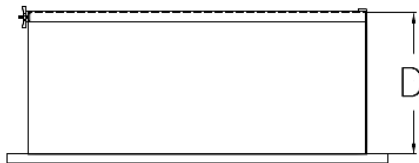
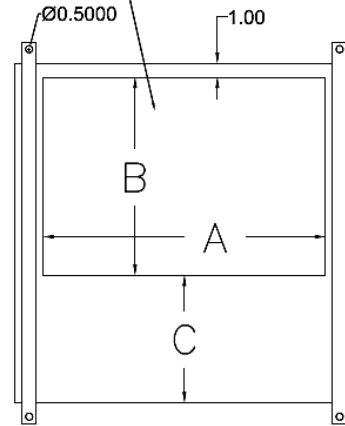
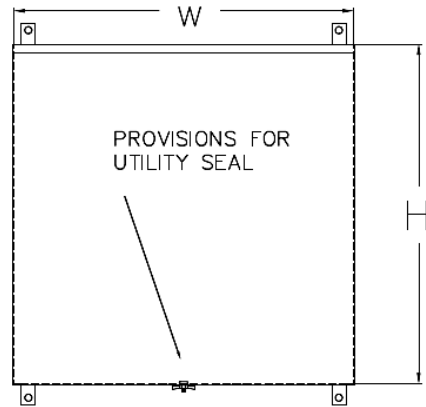

BOX SIZE			METAL GAUGE	BACK OPENING		
H	W	D		A	B	C
12	12	5	16	8	8	3
16	16	6	16	12	10	5
20	20	8	16	16	12	7
24	24	10	14	20	14	9
36	36	18	14	32	24	11
42	42	24	14	32	28	13

ALL MEASUREMENTS IN INCHES

K&S METAL ENCLOSURES
 42 X 42 X 24 WALL MOUNTED
 SPLICE BOX
 CATALOG #: M4242

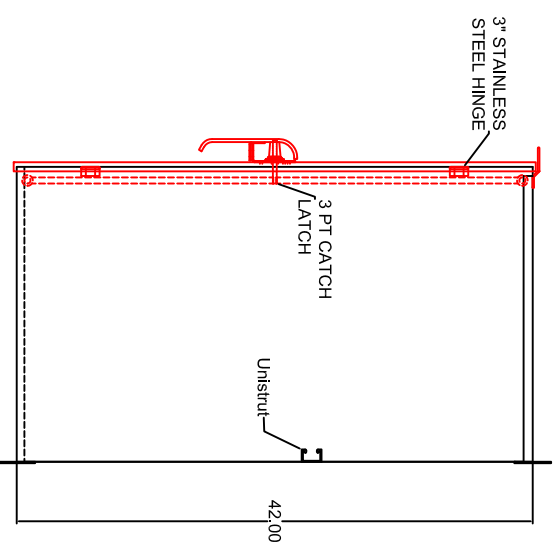
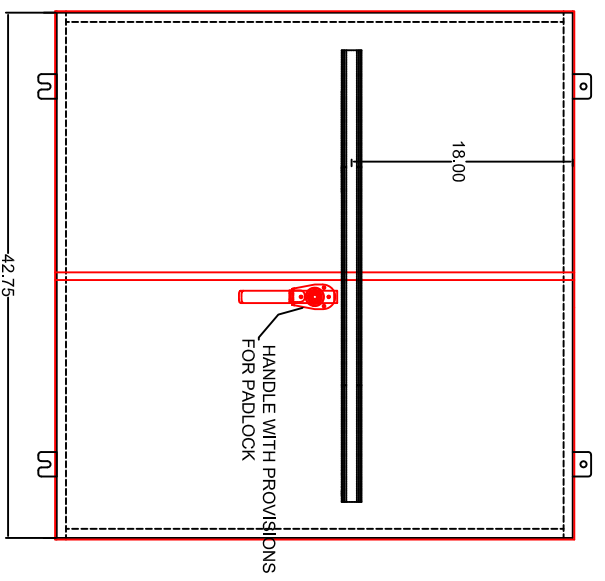
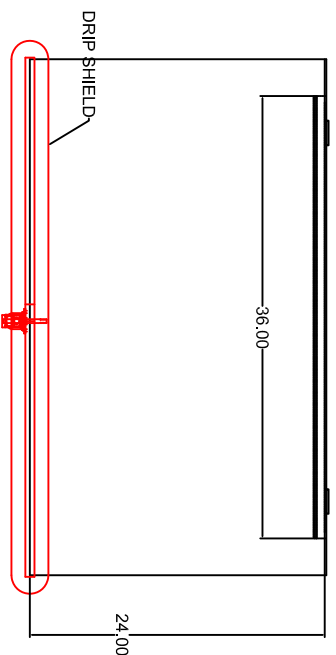

- NOTES:
- NEMA 3R OUTDOOR CONSTRUCTION
 - MOUNTING FEET TOP & BOTTOM OVERLAPPING DOORS ARE FURNISHED WITH 3PT CATCH PADLOCKING HANDLE, WITH GASKET ON DOORS
 - 36" PERFORATED UNISTRUT WELDED HORIZONTALLY INSIDE OF CABINET, 18" FROM TOP AND CENTERED LEFT TO RIGHT
 - STAINLESS STEEL LIFT OFF TYPE HINGES
 - 14 GAUGE GALVANIZED STEEL FINISH
 - REFERENCE PECO ELECTRIC SERVICE REQUIREMENTS MANUAL SECTION 10, ACCEPTED EQUIPMENT REV.-4

K&S METAL ENCLOSURES
 42 X 60 X 24 WALL MOUNTED
 SPLICE BOX
 CATALOG #: M6042

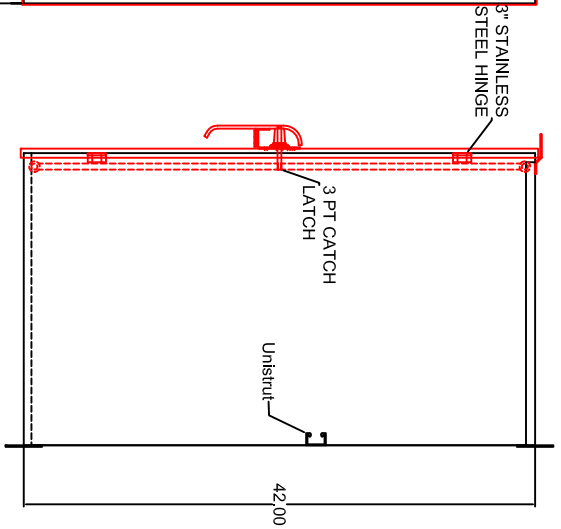
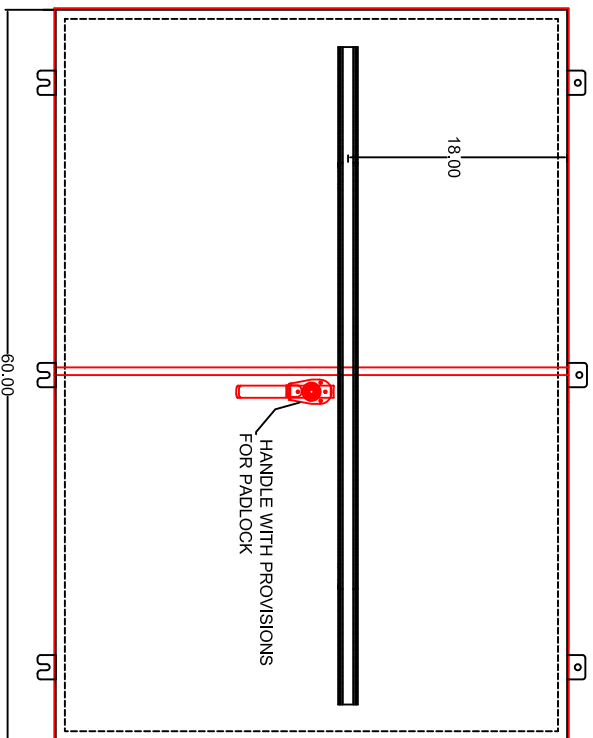
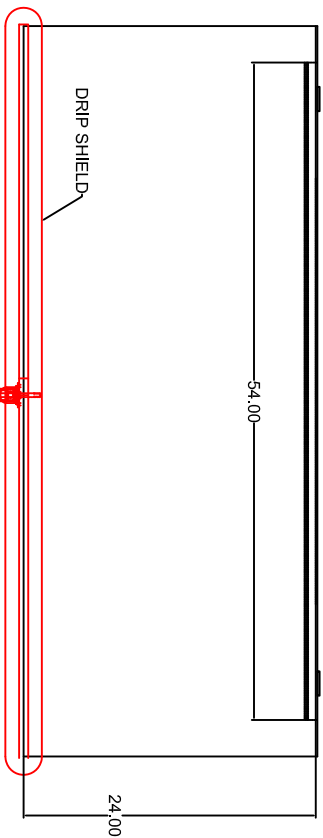

- NOTES:
- NEMA 3R OUTDOOR CONSTRUCTION
 - MOUNTING FEET TOP & BOTTOM
 - OVERLAPPING DOORS ARE FURNISHED WITH 3PT CATCH PADLOCKING HANDLE, WITH GASKET ON DOORS
 - 54" PERFORATED UNISTRUT WELDED HORIZONTALLY INSIDE OF CABINET, 18" FROM TOP AND CENTERED LEFT TO RIGHT
 - STAINLESS STEEL LIFT OFF TYPE HINGES
 - 14 GAUGE GALVANIZED STEEL FINISH
 - REFERENCE PECO ELECTRIC SERVICE REQUIREMENTS MANUAL SECTION 10 ACCEPTED EQUIPMENT REV.-4